



Special Crankcase set for Complete engine (4SMS)

(Takegawa original stud pattern)

0 1	0 0	0 0 2 8	(For 123cc only)
0 1	0 0	0 0 2 9	(For 138cc only)
0 1	0 0	0 0 4 1	(For SCUT 148cc only)

Thank you for purchasing one of our products.

This crankcase set made for our original complete engine only. There are up graded durability and liability from former (4SM) crankcase set. Our special clutch kit and generator cover is compatible with Monkey (Z50J-2000001 and up) This crankcase capable up to 148cc with wider stud pattern. You can build complete engine based on this crankcase. Please refer our parts catalog or ask our dealer for more information.

Please note that the descriptions in this manual like illustrations and photos may differ from the actual hardware.

Features

Oil pump drives by directly from crankshaft so that larger volume of oil delivered than stock chain drive type.

Crankcase has additional oil line to cool the piston and cylinder from inside.

The transmission shaft holds by ball type bearing.

Bearing hold plate is cooperated. (5 or 6 speed transmission only)

Read all instructions before starting the installation.

You may need more parts to using this crankcase kit.

You need to have specially made main shaft and counter shaft of the transmission need for this crankcase. (P.3 for reference)

01-00-0041 for SCUT 148cc only, not for 123cc or 138, unless boring.

Clutch cover must use current special clutch kit only. (Old type special clutch will not fit)

This case for our complete engine only, stock or even our kit parts will not fit. Please ask our dealer for more information.

CAUTION The following show the envisioned possibility of injuries to human bodies or property damage as a result of disregarding the following cautions.

- This product is designed for exclusive use on the closed course. Never use on public roads.
- Work only when the engine and the muffler are cool. (Otherwise, you will burn yourself.)
- Prepare right tools for the work, and do the work in the proper and right way.
(Otherwise, improper work could cause breakage of parts or injuries to yourself.)
- As some products and frames have sharp-pointed or protruding portions, please work with your hands protected. (Otherwise, you will suffer injuries.)
- Always use new gaskets and sealings. (Don not over use or worn parts, it may damage the engine)

WARNING The following show the envisioned possibility of human death or serious injuries to human bodies as a result of disregarding the following cautions.

- Those who are technically unskilled or inexperienced are required not to do the work.
(Improper installation due to unskilled technique or lack of knowledge could lead to parts breakage and consequently to accidents.)
- Before doing work, place the motorcycle on level ground to stabilize the position of your motorcycle for safety's sake.
(Otherwise, your motorcycle could fall down and injure you while you are working.)
- If the engine must be running to do some work, make sure the area is well ventilated. Never run the engine in an enclosed area.
- Gasoline is extremely flammable and is explosive under certain conditions. Keep out of reach of children.
- Always use a torque wrench to screw bolts and nuts tight and securely to the specified torque.
(Improper torque could cause these parts to get damaged or fall off.)
- Use specified or genuine Takegawa parts only. Never use and mixed with other manufactures parts.
- If you find damaged parts when checking and performing maintenance, do not use these parts any longer, and replace them with new ones.
(The continued use of these damaged parts as they are could lead to an accident.)
- When you notice something abnormal with your motorcycle while riding down a road, stop riding immediately and park your motorcycle in a safe place. (Otherwise, the abnormality could lead to an accident.)
- Before riding, always check every section for slack in parts like screws. If you find slack ones, screw them securely up to the specified torque.
(Or improper torque may cause parts to come off.)
- Check or perform maintenance of parts correctly according to the procedures in the instruction manual or a service manual.
(Improper checking or maintenance could lead to an accident.)
- Always use high-octane gasoline. (Otherwise, troubles such as engine knocking may cause accidents.)

Please be informed that, mainly because of improvement in performance, design changes, and cost increase, the product specifications and prices are subject to change without prior notice.

This manual should be retained for future reference.

~ Kit contains ~

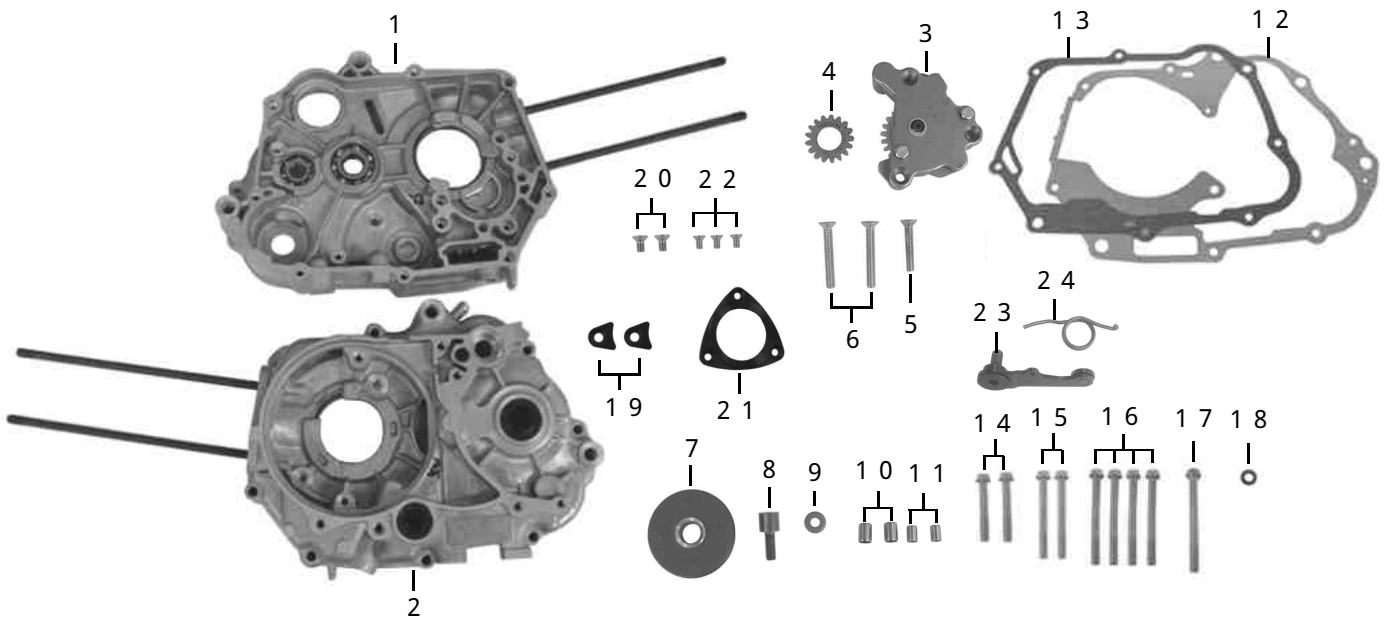

No.	Part name	Qty	Repair Part Item No.	In packs of
1	Right side crankcase assembly (123cc)	1	00-01-0270	1
2	Left side crankcase assembly (123cc)	1		1
1	Right side crankcase assembly (138cc)	1	00-01-0271	1
2	Left side crankcase assembly (138cc)	1		1
1	Right side crankcase assembly (148cc SCUT)	1	00-01-0272	1
2	Left side crankcase assembly (148cc SCUT)	1		1
3	Oil pump COMP.	1	00-01-0119	1
4	Oil pump drive gear	1	15341-GEF-T01	1
5	Flat head screw, M6 x 35	1	00-00-0155	4
6	Flat head screw, M6 x 45	2	00-00-0157	4
7	Cam chain guide roller COMP.	1	00-01-0122	1
8	Cam chain guide roller bolt	1	00-01-0123	1
9	Plain washer, 6.5 x 16 x 2.6	1	00-01-0118	2
10	Dowel pin, 10 x 14	2	00-01-0124	2
11	Dowel pin, 8 x 12	2	00-00-0153	2
12	Crankcase gasket	1	01-13-0609	1
13	Right side crankcase cover gasket	1		1
14	Flange bolt, M6 x 45	2	00-00-0361	1
15	Flange bolt, M6 x 60	2	00-00-0381	1
16	Flange bolt, M6 x 65	4	00-00-0382	1
17	Flange bolt, M6 x 70	1	00-00-0383	1
18	Copper sealing washer	1	00-01-0029	4
19	Mainshaft bearing hold plate	2	00-01-1040 (bolt set)	1set
20	Flat screw, M6 x 12	2	00-00-0384	2
21	Countershaft bearing hold plate	1	00-01-1041 (bolt set)	1set
22	Flat screw, M5 x 10	3	00-00-2778	4
23	Shift drum stopper arm COMP.	1	00-02-0025	1
24	Shift drum stopper spring	1	00-02-0152	1

Please order repair parts with the Repair Part Item No.

Without the repair part item No., we may not be able to provide the correct parts.

Some parts are only available as a set. Please order them with the set number.

SPECIAL PARTS TAKEGAWA Co.,Ltd.

3-5-16 Nishikiorihigashi Tondabayashi Osaka Japan TEL:81-721-25-1357 FAX:81-721-24-5059 URL: <http://www.takegawa.co.jp>

Transmission conversion parts (optional)

Counter / main shaft set for wet special clutch	
4 speed	01-00-0017 (Takegawa close transmission only)
5 speed	01-00-0005
5 speed (TAF)	02-04-0093
6 speed	01-00-0007

Counter / main shaft set for dry special clutch	
5 speed	01-00-0004
5 speed (TAF)	02-04-0094
6 speed	01-00-0006

Transmission kit

Applicable clutch kit	Transmission type	Item No.
Wet special clutch	Super street 5 speed (TAF)	02-04-0247
	S-touring (TAF)	02-04-0083
	6 speed close ratio	02-04-0095
Dry special clutch	Super street 5 speed (TAF)	02-04-0246
	S-touring (TAF)	02-04-0084
	6 speed close ratio	02-04-0096

Special Tools

Con' rod stopper
Item No.:00-01-01



Lock nut wrench
Item No.:00-01-021 for 12.7 mm (1/2)
00-01-022 for 19.5 mm (3/8)



Flywheel puller
Item No.:00-01-031

Universal holder
Item No.:00-01-1002



Puller adapter
Item No.: 00-01-1027



Crank shaft installer & Puller set
Item No.:00-01-1008
(3-point support crank only)

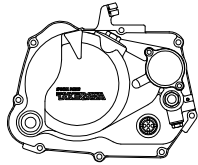
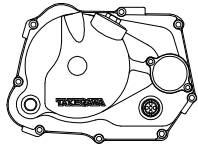
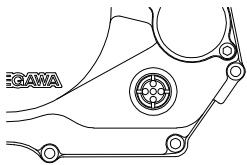
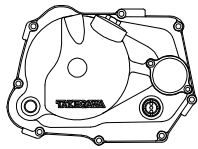
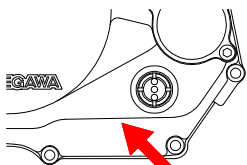
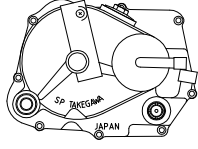
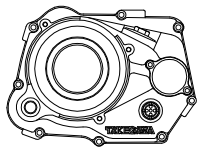
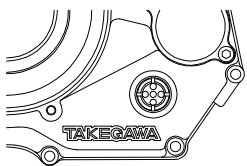
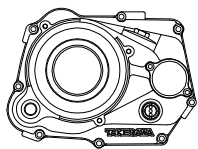
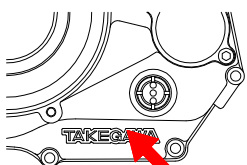
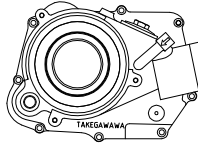

Please check the applicable clutch cover kit.

		Clutch cover type		Applicable	Note
Wet type clutch	Die cast				• Good
	Sand cast 1	Current model	 		• Good
		Old type	 	×	• Interface with oil pump, cannot install.
	Sand cast 2			×	• Interface with oil pump, cannot install. • Non oil filter type.
Dry type clutch	Sand cast 1	Current model	 		• Good
		Old type	 	×	• Interface with oil pump, cannot install.
	Sand cast 2			×	• Interface with oil pump, cannot install. • Forward type oil filter.

Installation Procedures

Please note: Illustrations and photos may vary from actual hardware.

Installation for main shaft bearing hold pate

Install this bearing hold pate for 5 or 6-speed transmission ONLY.

⚠ Caution: Do not use with 4-speed transmission.

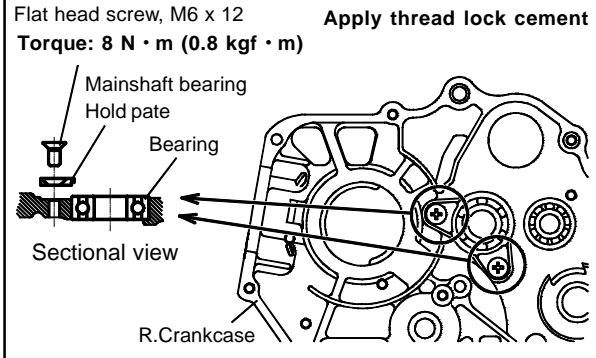

Install shift return spring pin on the R side crankcase to the pecified torque.

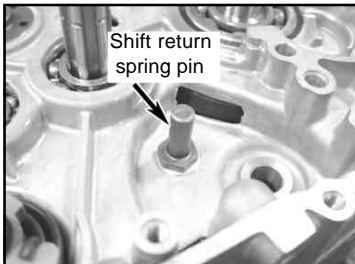

⚠ Caution: Apply the specified torque.
Torque: 13 N · m (1.3 kgf · m)

Shift return spring pin
Takagawa P / N : 00-01-0273

Assembly of Crankshaft

(In the Case of Three-Point-Support Crankshaft)

Attach the plate of the crankshaft puller set included in the tool set to the right side crankcase with a 6x20 screw.

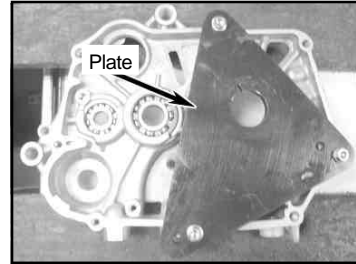

Crankshaft installer & puller set:
Takagawa P / N : 00-01-1008

Install firmly the threaded shaft to the crankshaft, and then an installer collar and installer nut.

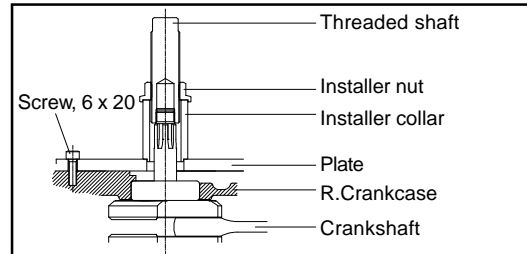

Holding the threaded shaft, turn the installer collar nut counterclockwise so the crankshaft comes up.

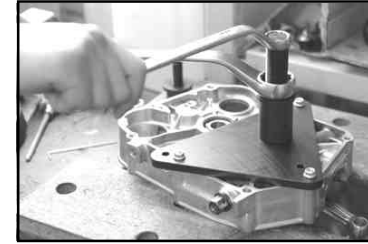

When the crankshaft bearing is in close contact with the crankcase, the crankshaft is already at the desired place.

⚠ Caution: Pulling up the crankshaft further upward even after the bearing has come in close touch with the crankcase, the crankcase will get damaged. Therefore, do the work with care.

Install plane washer and guide roller.

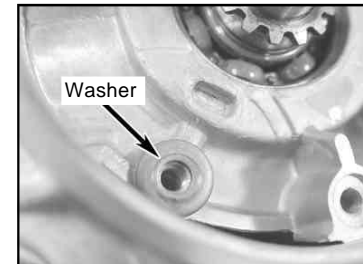

⚠ Caution: Apply the specified torque.
Torque: 13 N · m (1.3 kgf · m)

Installation Procedures

Install cam chain tensioner, pivot and roller to the specified torque.

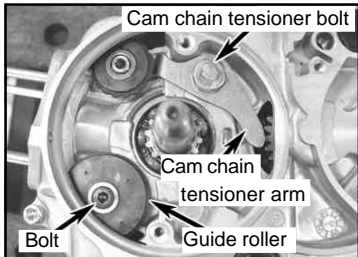

⚠ Caution: Apply the specified torque.

Torque: 16 N · m (1.6 kgf · m)

Cam chain tensioner arm
Takagawa P / N : 00-01-0274
Cam chain tensioner roller
Takagawa P / N : 00-01-0275
Cam chain tensioner pivot
Takagawa P / N : 00-01-0276

Install push rod tensioner spring, washer with sealing washer to the specified torque.

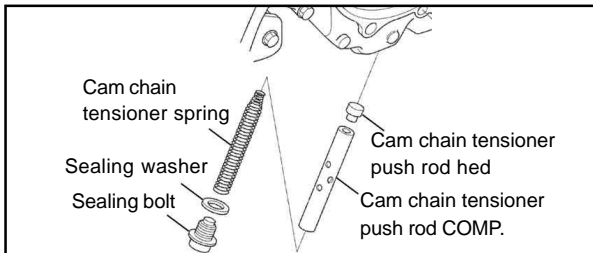

⚠ Caution: Apply the specified torque.

Torque: 22 N · m (2.2 kgf · m)

Cam chain tensioner spring
Takagawa P / N : 00-01-0277
Cam chain tensioner push rod COMP.
Takagawa P / N : 00-01-0278
Cam chain tensioner push rod hed
Takagawa P / N : 00-01-0279
Sealing bolt
Takagawa P / N : 00-01-0280
Sealing washer
Takagawa P / N : 00-01-0281

Installation Procedures

Install transmission

4-speed transmission and wet special clutch

Assemble main shaft and counter shaft with circlip

Apply molybdenum solution to every gear and assemble gears.

In installing the thrust washer, install its curved portion in the direction where the heavier load is on the thrust washer.

• Mainshaft

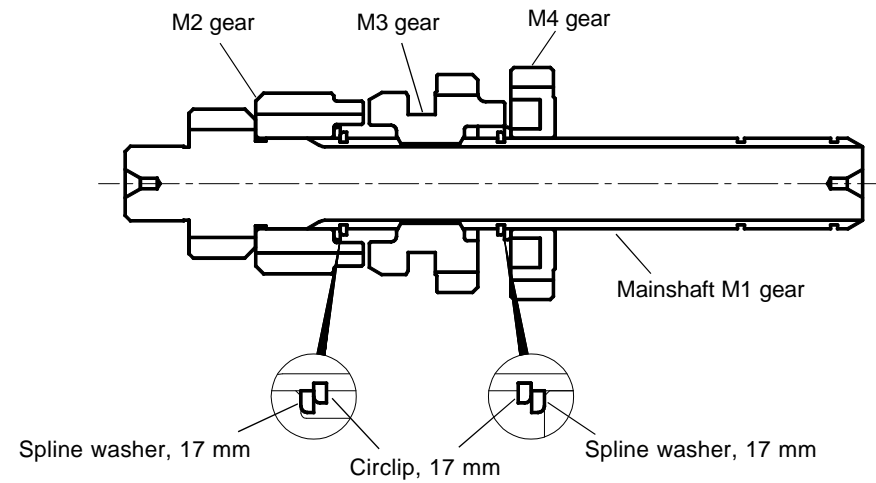

• Countershaft

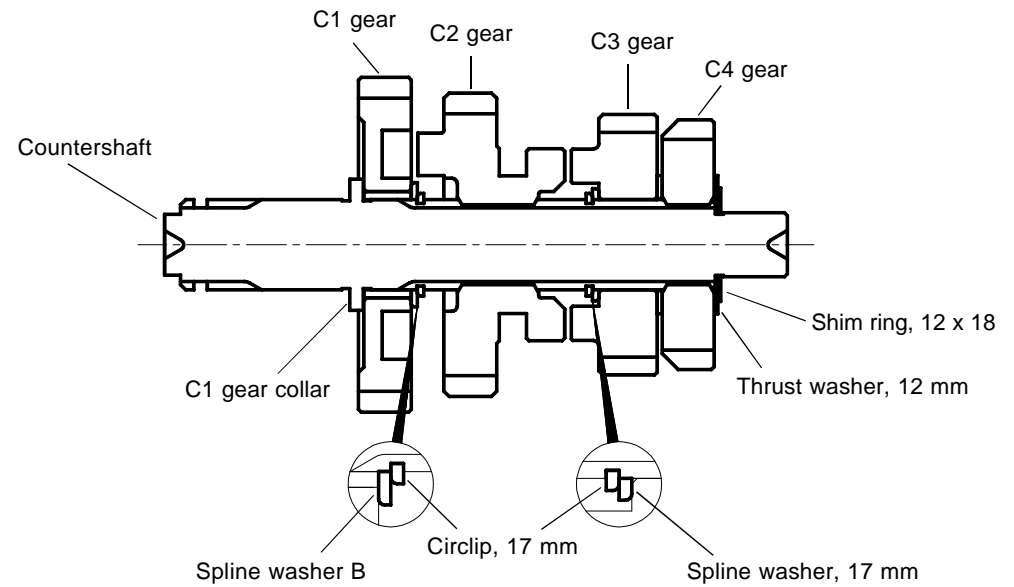

Installation Procedures

5-speed transmission and wet special clutch

Assemble main shaft and counter shaft with circlip

Apply molybdenum solution to every gear and assemble gears.

In installing the thrust washer, install its curved portion in the direction where the heavier load is on the thrust washer.

• Main shaft for wet-type clutch

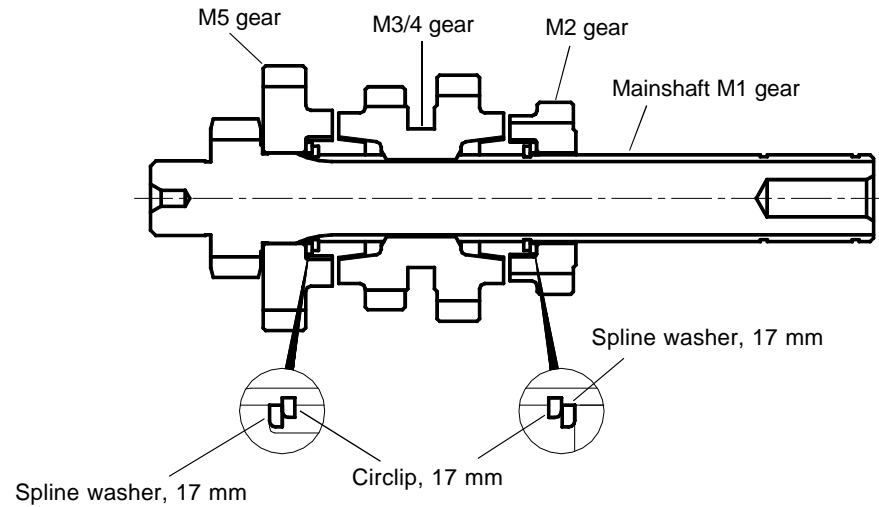

• Countershaft

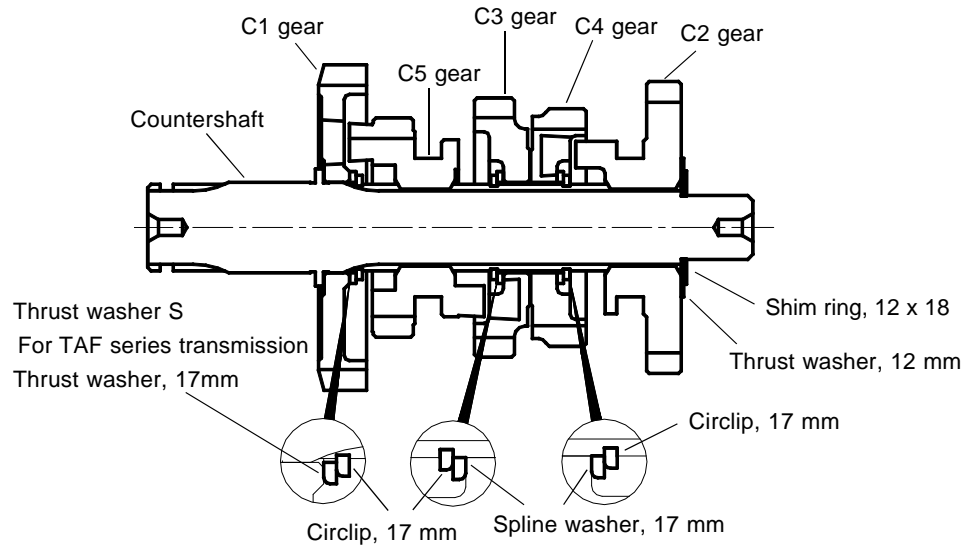

Installation Procedures

5-speed transmission and wet special clutch

Assemble main shaft and counter shaft with circlip

Apply molybdenum solution to every gear and assemble gears.

In installing the thrust washer, install its curved portion in the direction where the heavier load is on the thrust washer.

• Main shaft for dry-type clutch

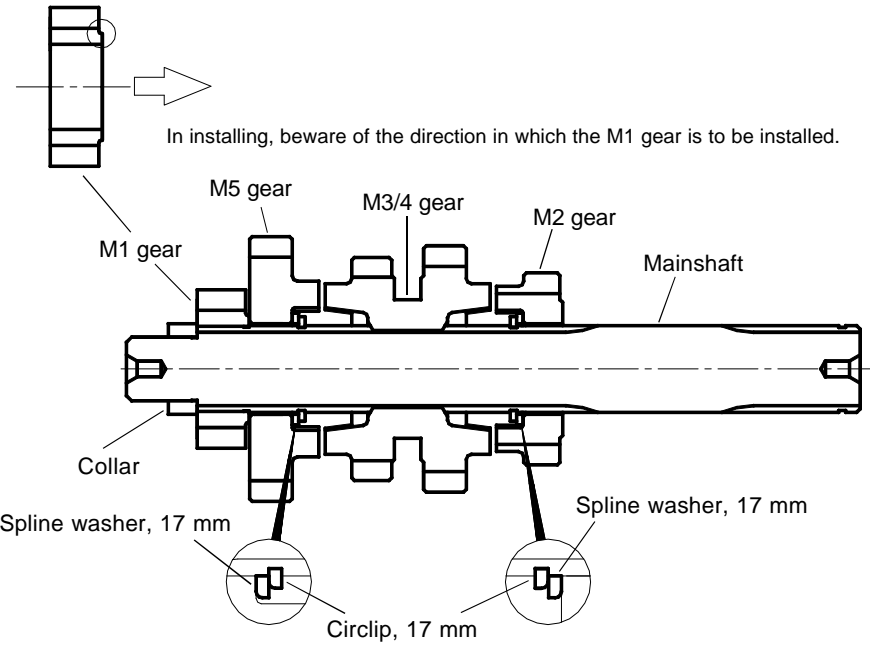

• Countershaft

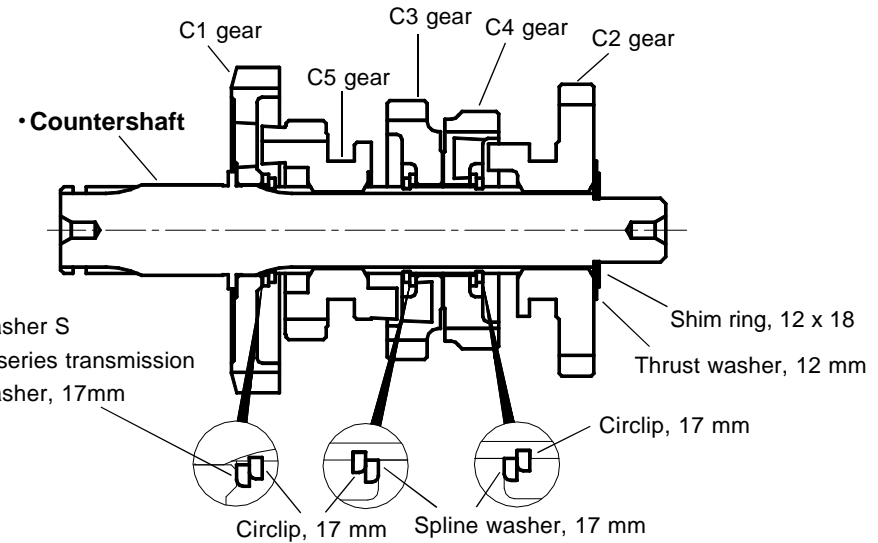

Installation Procedures

6-speed transmission and wet special clutch

Assemble main shaft and counter shaft with circlip

Apply molybdenum solution to every gear and assemble gears.

In installing the thrust washer, install its curved portion in the direction where the heavier load is on the thrust washer.

• Mainshaft for wet-type clutch

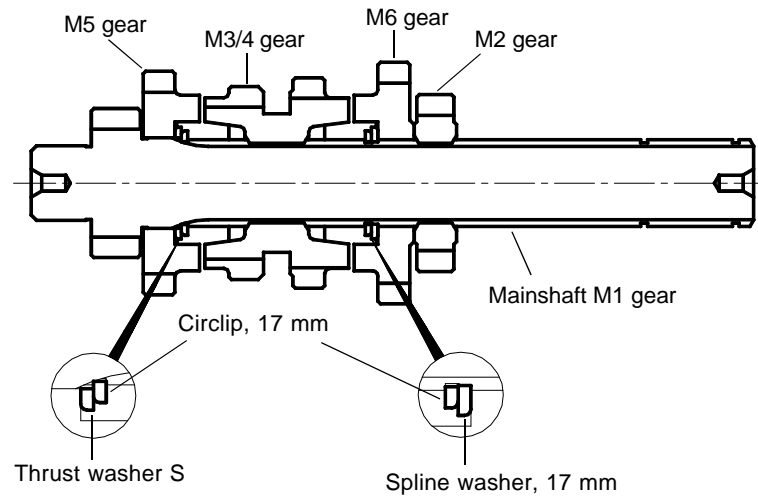

• Countershaft

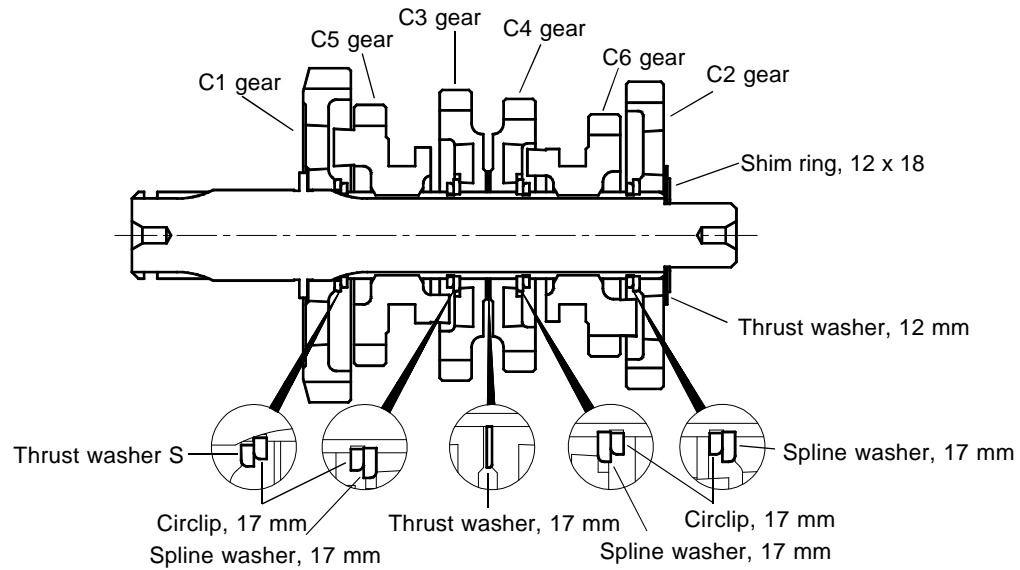

Installation Procedures

6-speed transmission and wet special clutch

Assemble main shaft and counter shaft with circlip

Apply molybdenum solution to every gear and assemble gears.

In installing the thrust washer, install its curved portion in the direction where the heavier load is on the thrust washer.

• Mainshaft for dry-type clutch

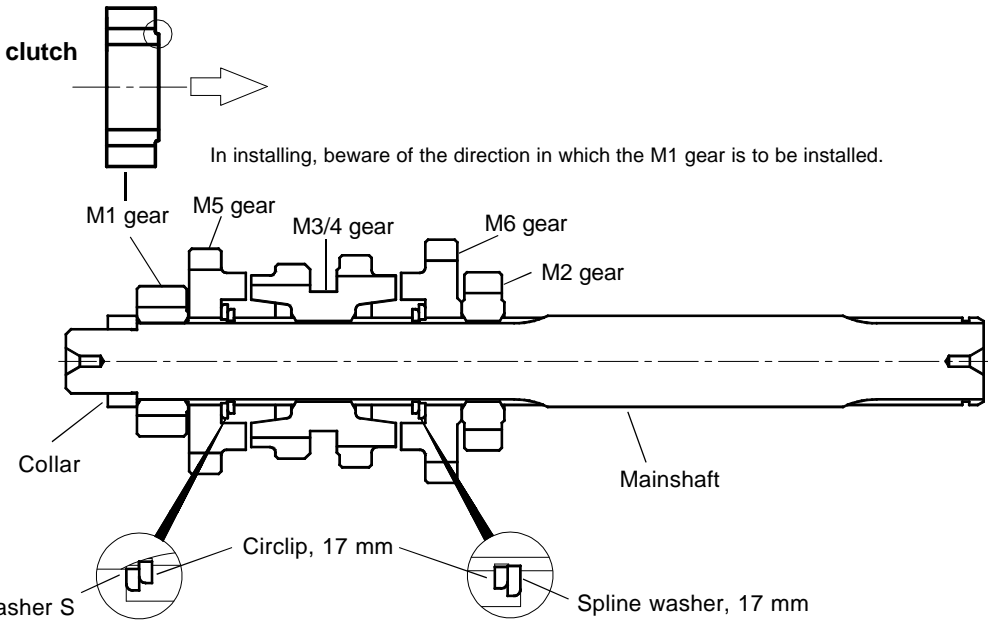

• Countershaft

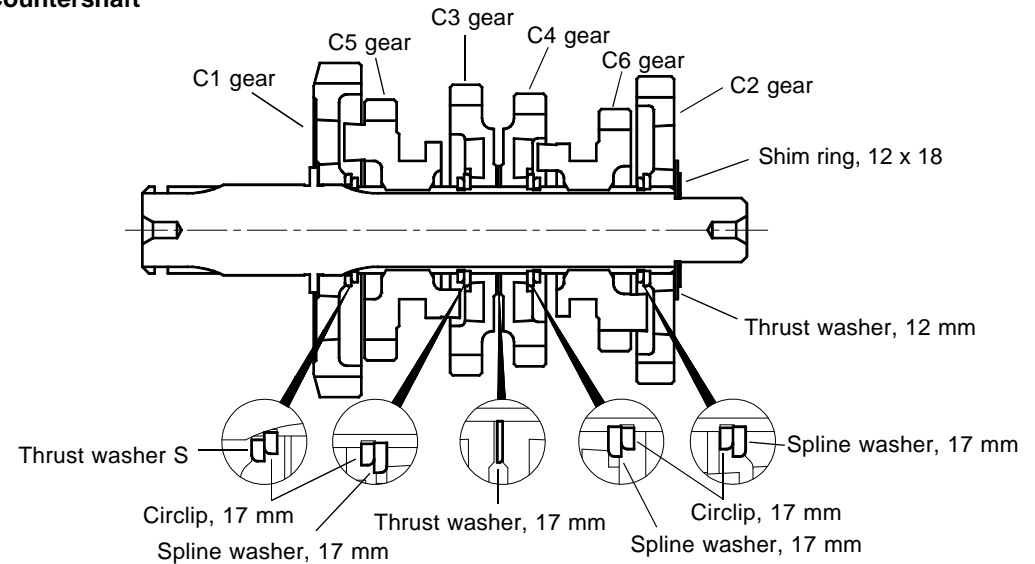

Installation Procedures

Transmission and crankcase assembly

Apply engine oil to each gear.

Join together the mainshaft and countershaft to which gears have been installed. After aligning the shift forks with shifter gear grooves, attach the shift drum to the transmission.

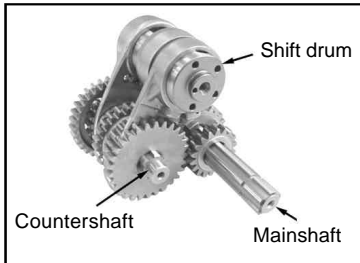

Install transmission assembly in Neutral gear position.

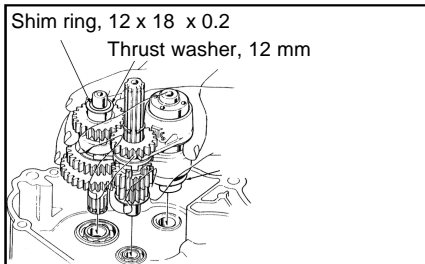

Install the kick starter spindle aligning its friction spring end with the groove in the left crankcase.

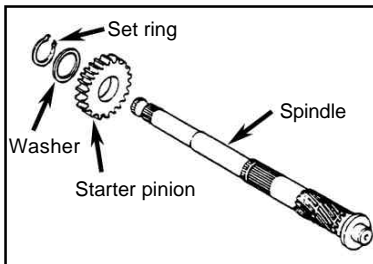

Kick starter spindle kit
Takagawa P / N : 02-04-0011

Attach the drive ratchet to the kick starter spindle, and secure it with a set ring.

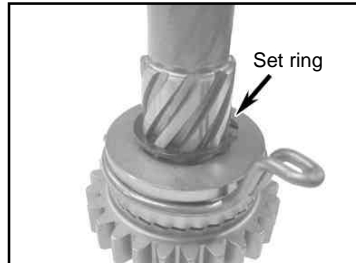

Attach the kick starter spindle to the left side crankcase, and install the washer then.

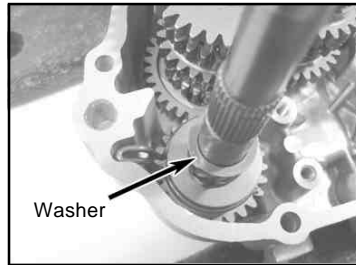

Degrease well the mating surface of the left side crankcase, and attach dowel pins.

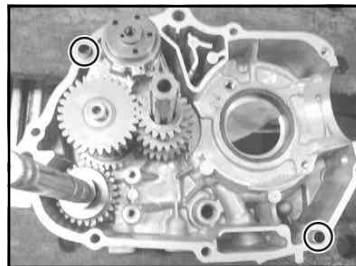

Attach a new gasket to the left side crankcase.

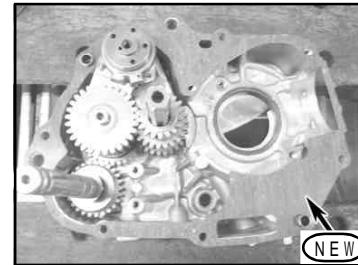

Install crank shaft (2 point crank) and right crankcase over the left crankcase.



Install and tighten the crankcase bolt in a crisscross pattern in 2-3 steps.

Only 6x70 bolt tight with copper sealing washer.

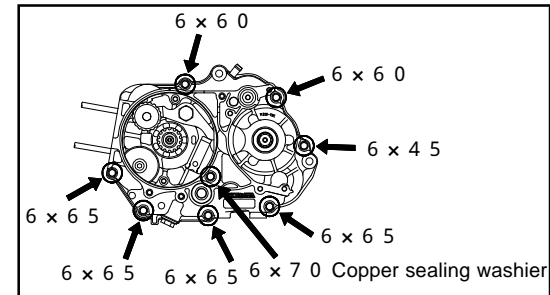

⚠ Caution: Apply the specified torque.

Torque: 10 N · m (1.0 kgf · m)

Installation Procedures

Install the washer and bolt to the shift drum. Then tighten the bolt to the specified torque.
Install the rubber plug.

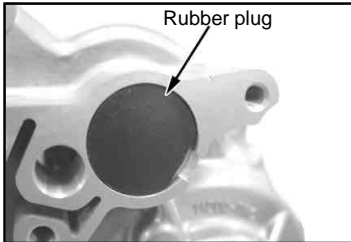
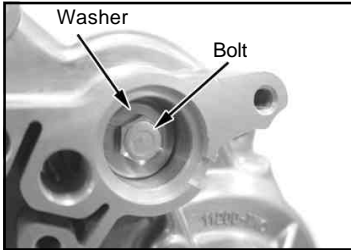

⚠ Caution: Apply the specified torque.
Torque: 10 N · m (1.0 kgf · m)

Install neutral switch contact and tighten with plate.

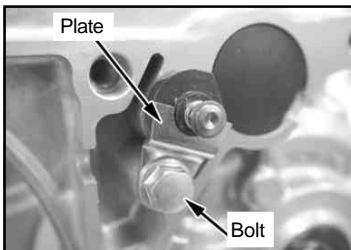
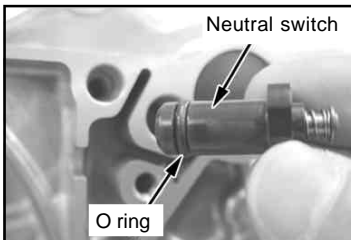

Install the return spring and retainer onto the kick starter spindle.
Install the spring ends onto the retainer and crankcase lug while turning the spindle counterclockwise.

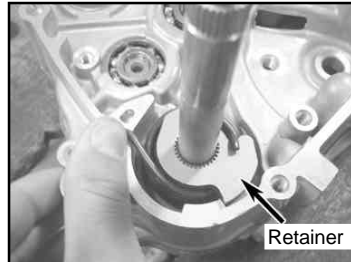

Attach the external circlip to the spindle.

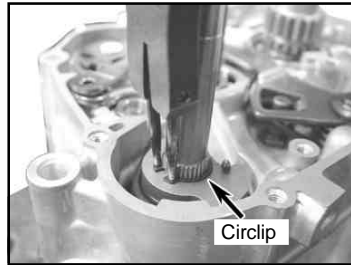

For 6-speed transmission, modify the gearshift arm as shown.

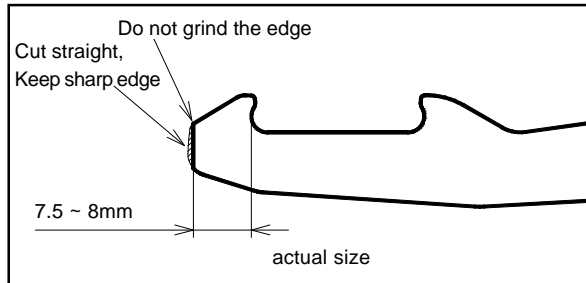

Attach the collar and return spring to the gearshift arm.

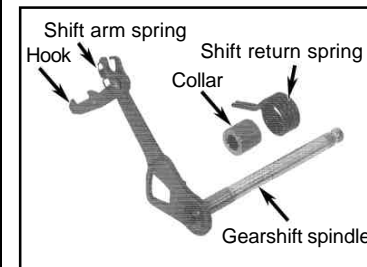

Collar, 12.2mm
Genuine Honda parts number : 24639-035-000
Gearshift return spring
Genuine Honda parts number : 24651-035-000

Install the gearshift arm onto the crankcase.

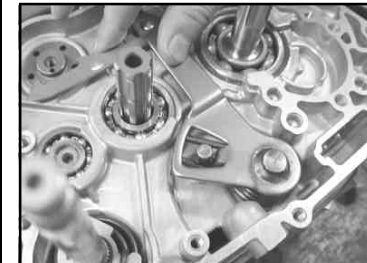

Locate two kinds of drum pins on the shift drum.

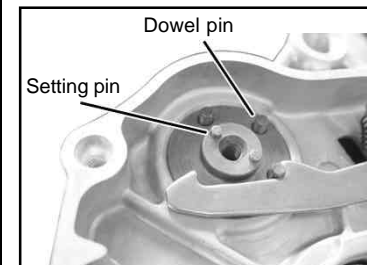

Close-ratio 4-speed

Installation Procedures

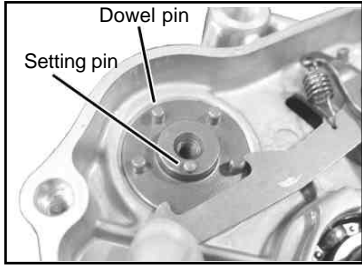

Close-ratio 5-speed
1 setting pin type

• Set the drum pin into the hole on the stopper plate. And apply a thin coat of thread lock to the dowel bolt, and tighten the dowel bolt to the specified torque.

△ Caution: Apply the specified torque.
Torque: 16 N · m (1.6 kgf · m)

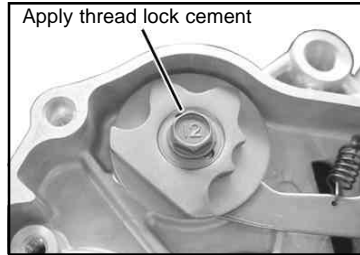

Close-ratio 4-speed
• Set the stopper plate with the concave portion in the center to face outward.

Attach the shift drum stopper spring and shift drum stopper to the crankcase, and tighten them to the specified torque.

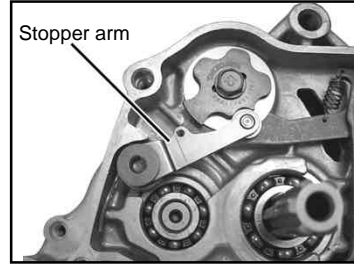

△ Caution: Apply the specified torque.
Torque: 10 N · m (1.0 kgf · m)

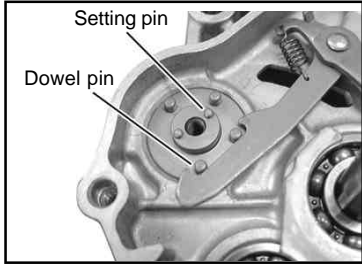

2 setting pin type

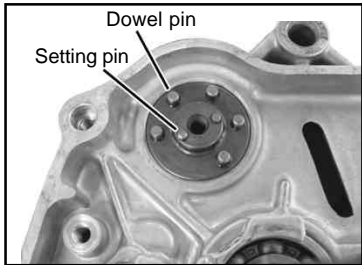

Close-ratio 6-speed

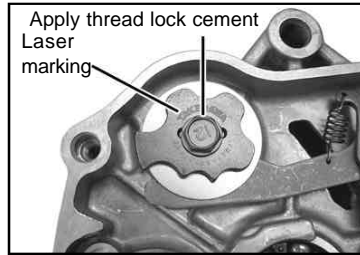

Close-ratio 5-speed

Check whether the gear is installed all right or not.
While keeping the mainshaft rotating, check how the gear is installed by rotating the dowel bolt on the stopper plate with a wrench.

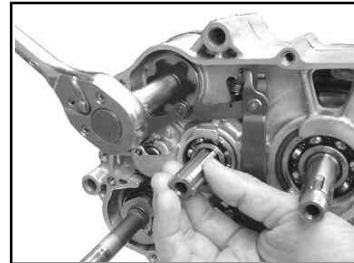

Check that there is some free play in the end thrust in the mainshaft and countershaft.

Do not rotate the shift drum forcibly.

Attach the shift drum side plate to the drum pin.

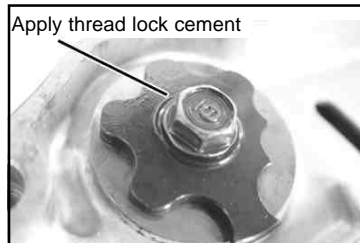
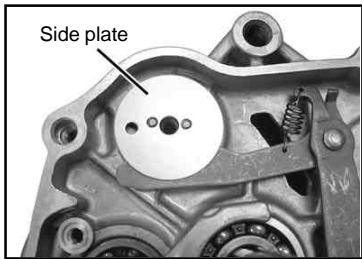

Close-ratio 6-speed
• Set the stopper plate with the convex portion in the center to face outward.

Installation Procedures

Install oil pump

Install kitted oil pump gear groove faced outside.

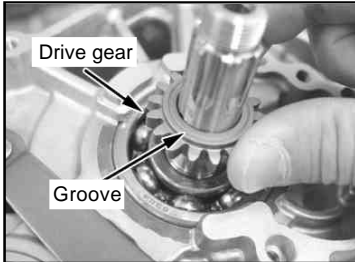

Install primary drive gear.

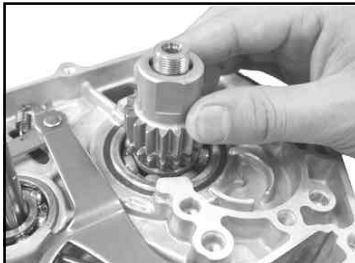

Locate a conical spring washer and then a lock nut.

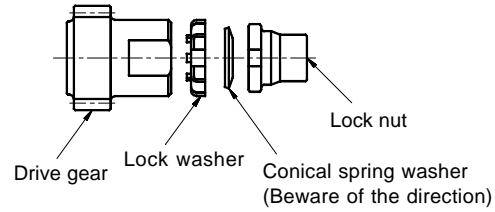

Locate the conical washer, being careful of the direction of the conical spring washer.

Install the connecting rod stopper, included in the tool set, to the connecting rod.

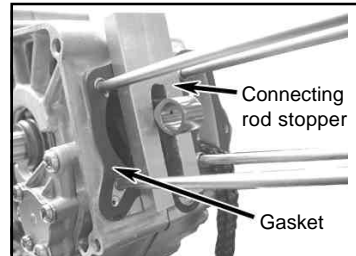

Connecting rod stopper
Takagawa P / N : 00-01-011

Tighten the lock nut to the specified torque using the lock nut wrench included in the tool set.



⚠ Caution: Apply the specified torque.
Torque: 41 N · m (4.0 kgf · m)

Fit the hook of the lock washer into the concave portion of the lock nut.

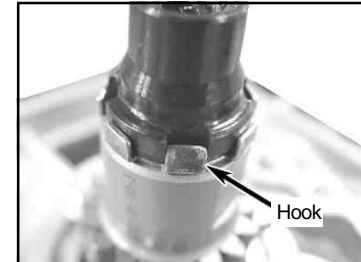

⚠ Caution: if the hook on the lock washer does not fit in the concave of the lock nut, turn the lock nut in the direction of tightening so the hook fits right into the concave.

Install dowel pin (8x12) on the right crankcase.

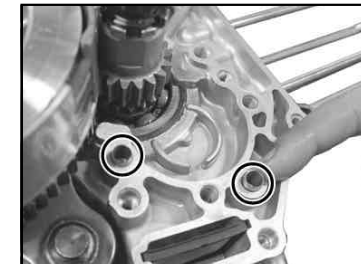

Install oil pump with flat head screw to the specified torques.

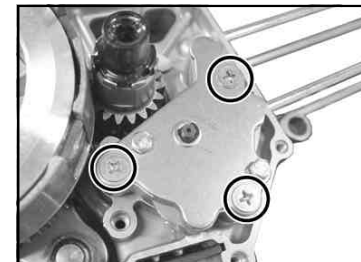

⚠ Caution: Apply the specified torque.
Torque: 9 N · m (0.9 kgf · m)

Installation Procedures

Clutch installation

Refer the clutch kit installation manual, and install clutch cover. R cover must be current model; our old R cover will not fit.

Cylinder installation

Install cam chain (chain link may different by the strokes)

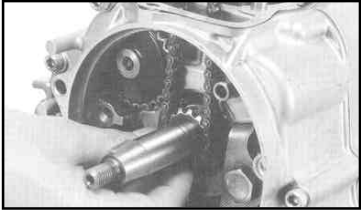

Refer the cylinder kit installation manual.

Cylinder Head installation

Refer the cylinder head kit manual.

Ignition system installation

Fix O-rings onto two locations.

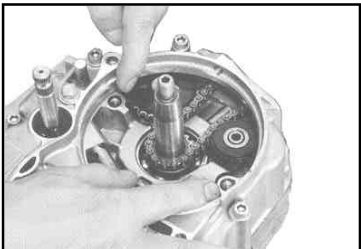

Install a generator plate, and tighten the flat screws.

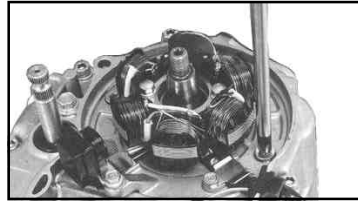

Install grommet and connect neutral switch.

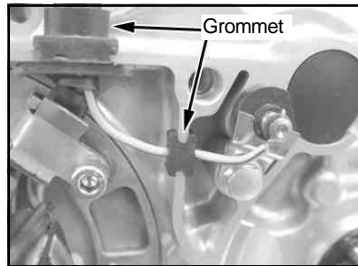

Refer the installation manual of ignition system.

Fix the woodruff key to the crank shaft.
Clean any oil from the crankshaft taper. Then install the woodruff key, flywheel and nut to the specified torque.

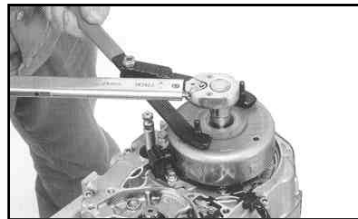

⚠ Caution: Refer crankshaft manual.

Generator cover installation

Install generator cover, use specified bolt (M6x45) as shown to the specified torque.

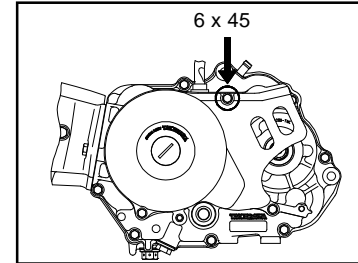

⚠ Caution: Apply the specified torque.

Torque: 10 N · m (1.0 kgf · m)